

Intrinsically Safe Pressure Transmitters for installation in hazardous locations

Models IS-20-S, IS-21-S, IS-20-F, IS-21-F

WIKAI Datasheet IS-20



Applications

- Chemical, Petrochemical
- Oil and gas refining
- Food industry
- Mechanical engineering

Special Features

- Pressure ranges from 50 INWC to 15,000 PSI
- FM, CSA approval for
 - Intrinsically safe Class I, II and III Division 1, Group A, B, C, D, E, F, G
 - Dust Class II and III Division 1, Group E, F, G
 - Class I, Zone 0, AEx ia II C
- Ex- protection EEx ia I/II C T6 according to ATEX for:
 - Gases, vapors and mist: Connection to Zone 0, Zone 1 and Zone 2
 - Dust: Connection to Zone 20, Zone 21 and Zone 22
 - Mining: Category M1 and M2



Left: IS-20-S standard version
Center: IS-21-S with flush diaphragm
Right: IS-20-F with integral junction box

Description

Approvals meet international standards

The IS-20 series of intrinsically safe pressure transmitters are designed for industrial pressure measurement applications in hazardous areas where intrinsically safe ratings are required.

Multiple intrinsically safe approvals include FM, ATEX, and CSA. These multiple approvals provide for global recognition and acceptance of the intrinsically safe ratings. The transmitters are labeled with all three approvals to help support international shipments of OEM equipment designed with these transmitters.

Rugged construction

The stainless steel wetted parts feature an all-welded measuring cell for improved media compatibility. There are no internal soft sealing materials that may react with the media or deteriorate over time. The compact case is also made of stainless steel and is available with environmental protection ratings up to NEMA 6 (IP 68).

The IS-21-S and IS-21-F transmitters feature a flush diaphragm process connection. They are specifically designed for the measurement of viscous fluids or media containing solids that may clog a NPT process connection.

Models IS-20-F and IS-21-F feature an integral stainless steel junction box with internal terminal block for use in extremely harsh environments. A 1/2" NPT female conduit connection is standard on all models and a cable compression electrical connection is available as an option.

All models require a 10 to 30 volt supply provided by an intrinsically safe power supply or through an approved intrinsically safe zener diode barrier.

Specifications without model designation apply for all models.

Pressure range	50INWC	5PSI	10PSI	25PSI	30PSI	60PSI	100PSI	160PSI	200PSI
Maximum pressure*	15PSI	29PSI	58PSI	145PSI	145PSI	240PSI	500PSI	1160PSI	1160PSI
Burst pressure**	30PSI	35PSI	69PSI	170PSI	170PSI	290PSI	600PSI	1390PSI	1390PSI
Pressure range	300PSI	500PSI	1000PSI	2000PSI	3000PSI	5000PSI	8000PSI	10000PSI ¹⁾	15000PSI ¹⁾
Maximum pressure*	1160PSI	1160PSI	1740PSI	4600PSI	7200PSI	11,600PSI	17,400PSI	17,400PSI	21,750PSI
Burst pressure**	1390PSI	5800PSI	7970PSI	14,500PSI	17,400PSI	24,650PSI ²⁾	34,800PSI ²⁾	34,800PSI	43,500PSI

(vacuum, gauge pressure, compound ranges, and absolute pressure references are available)

¹⁾ Ranges only available with Type IS-20

²⁾ For type IS-21 the burst pressure is limited to 21,000PSI unless the pressure seal is accomplished by using the sealing ring underneath the hex.

*Pressure applied up to the maximum rating will cause no permanent change in specifications but may lead to zero and span shifts

**Exceeding the burst pressure may result in destruction of the transmitter and possible loss of media

Materials

<ul style="list-style-type: none"> ■ Wetted parts <ul style="list-style-type: none"> ➢ Models IS-20-S, IS-20-F ➢ Models IS-21-S, IS-21-F ■ Case 		(for other materials see WIKA diaphragm seal program)
		Stainless steel
		Stainless steel {Hastelloy C4}
		O-ring: NBR {Viton or EPDM}
Internal transmission fluid ³⁾		Synthetic oil {Halocarbon oil for oxygen applications} ⁴⁾ {Listed by FDA for food applications}

³⁾ Not available with Model IS-20 in pressure ranges > 300 PSI

⁴⁾ Media temperature for oxygen version: -30 ... +60 °C / -22 ... +140 °F. Not available in vacuum or absolute pressure ranges or in Model IS-21 flush diaphragm version > 500 PSI

Power supply U _B	DC V	10 < U _B ≤ 30 (11 < U _B ≤ 30 with Model IS-2*-F)									
Signal output and Maximum load R _A		4 ... 20 mA, 2-wire									
<ul style="list-style-type: none"> ➢ Model IS-2*-S ➢ Model IS-2*-F 		R _A ≤ (U _B - 10 V) / 0.02 A - (length of cable in feet x 0.043 Ohm)									
		R _A ≤ (U _B - 11 V) / 0.02 A									
		with R _A in Ohms and U _B in Volts									
Test circuit signal / max. load R _A		R _A < 15 Ohm (only for Model IS-2 *-F)									
Adjustability zero/span	%	± 10 using potentiometers inside the instrument									
Response time (10 ... 90 %)	ms	≤ 1 (≤ 10 ms at media temperatures below -22°F (-30°C) for ranges < 300 PSI									
Isolation voltage		Insulation complies with EN 50020, 6.4, 12									
Accuracy ⁵⁾	% of span	≤ 0.25 {0.125} ⁶⁾ (BFSL)									
	% of span	≤ 0.5 {0.25} ⁶⁾ (limit point calibration)									
		⁵⁾ Including linearity, hysteresis and repeatability.									
		Limit point Calibration performed in vertical mounting position with pressure connection facing down.									
		⁶⁾ For pressure ranges above 100 INWC									
Repeatability	% of span	≤ 0.05									
1-year stability	% of span	≤ 0.2 (at reference conditions)									
Permissible temperature											
<ul style="list-style-type: none"> ■ Medium ^{7) 8)} ■ Ambient ^{7) 8)} ■ Storage ⁸⁾ 		<table border="0"> <tr> <td>-22 ... +221°F</td> <td>-30 ... +105°C</td> <td>{extended temperature ranges see Page 6} ⁹⁾</td> </tr> <tr> <td>-22 ... +221°F</td> <td>-30 ... +105°C</td> <td></td> </tr> <tr> <td>-40 ... +221°F</td> <td>-30 ... +105°C</td> <td></td> </tr> </table>	-22 ... +221°F	-30 ... +105°C	{extended temperature ranges see Page 6} ⁹⁾	-22 ... +221°F	-30 ... +105°C		-40 ... +221°F	-30 ... +105°C	
-22 ... +221°F	-30 ... +105°C	{extended temperature ranges see Page 6} ⁹⁾									
-22 ... +221°F	-30 ... +105°C										
-40 ... +221°F	-30 ... +105°C										
		⁸⁾ Also complies with EN 50178, Tab. 7, Type C, Class 4KH Operation, 1K4 Storage, 1K3 Transport									
		⁹⁾ Response time for IS-20: ≤ 10 ms at medium temp. below -30 °C (-22 °F) for pressure ranges up to 300 PSI									
		Response time for IS-21: ≤ 10 ms at medium temp. below -30 °C (-22 °F) for all pressure ranges									
Compensated temperature range		32 ... +176°F 0 ... +80°C									
Temperature coefficients (TC) within compensated temperature range:											
<ul style="list-style-type: none"> ■ Mean TC of zero ■ Mean TC of range 	% of span	≤ 0.2 / 10 K (< 0.4 for pressure range ≤ 100 INWC)									
	% of span	≤ 0.2 / 10 K									
-protection	ATEX	Categories ⁷⁾ 1G, 1/2G, 2G, 1D, 1/2D, 2D, M1, M2									
Ignition protection type		EEx ia I/II C T4, EEx ia I/II C T5, EEx ia I/II C T6									
-protection	FM, CSA	Class I, II and III									
Ignition protection type		Intrinsically safe Class I, II, III Division 1, Groups A, B, C, D, E, F, G and Class I, Zone 0 AEx ia II C									
		7) Refer to the EC type-examination certificate (BVS 04 ATEX E 068 X) for more information									

Specifications

Models IS-20-S, IS-21-S, IS-20-F, IS-21-F

CE - conformity		89/336/EWG interference emission and immunity see EN 61 326, interference emission limit class A and B EN 50 014 (general part), EN 50 020 (intrinsic safety), {EN 50 284 (Zone 0)}, {EN 50 281-1 (dust-Ex)}, {EN 50 303 (mining industry)}
FM, CSA		FM standards according to FMRC 3600, 3610, 3611 (including supplement #1), ISA-S12.0.01, IEC 60 529 (including amendment #1) CSA standard C22.2 No. 0-M1991 / 142-M1987 / 157-M1992 UL 50, Eleventh Edition / UL 508, Seventeenth Edition / UL 913, Sixth Edition
HF-immunity	V/m	10
BURST	KV	2
Shock resistance		
> Model IS-2*-S	g	1000 according to IEC 60068-2-27 (mechanical shock)
> Model IS-2*-F	g	600 according to IEC 60068-2-27 (mechanical shock)
Vibration resistance		
> Model IS-2*-S	g	20 according to IEC 60068-2-6 (vibration under resonance)
> Model IS-2*-F	g	10 according to IEC 60068-2-6 (vibration under resonance)
Wiring protection		Protected against reverse polarity and short circuiting
Weight		
> Model IS-2*-S	lb	Approx. 0.45
> Model IS-2*-F	lb	Approx. 0.80

{ } Items in curved brackets { } are optional extras at additional cost.

Output signal and permissible load

Model IS-2*-S

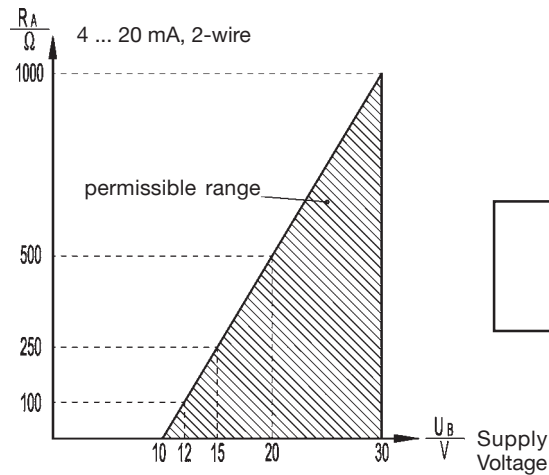

Output current (2-wire)

$$4 \dots 20 \text{ mA: } R_A \leq (U_B - 10 \text{ V}) / 0.02 \text{ A}$$

Model IS-2*-F

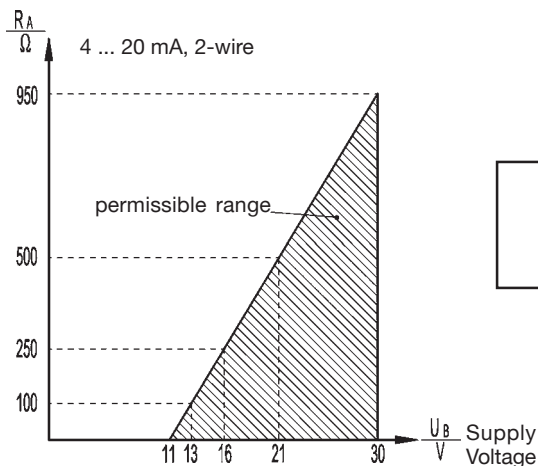

Output current (2-wire)

$$4 \dots 20 \text{ mA: } R_A \leq (U_B - 11 \text{ V}) / 0.02 \text{ A}$$

Dimensions in inches (mm)

IS-2*-S (electrical connections)

Ingress Protection IP per IEC 60 529

L-connector plug
DIN EN 175301-803,
Form A
½ NPT conduit
IP 65
Order code: AX
ATEX: 1/2 G, M1

Circular connector,
M 12x1, 4-pin
IP 67
Order code: M4
ATEX: 1/2 G, M1

Cable with free ends
outer conductor
diameter 6.8 mm, PUR
NEMA 4 / IP 67
Order code: DL
ATEX: 1/2 G, M1

Bayonet connector
6-pin NEMA 4 / IP 67
Order code: C6
ATEX: 1/2 G
(not available with
mining approval)

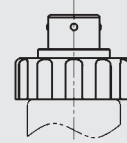
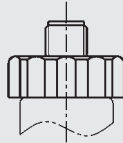
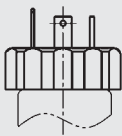
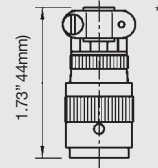
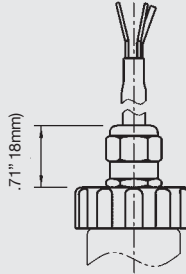
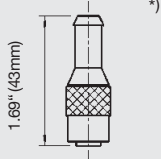
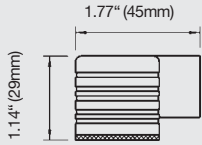

Case

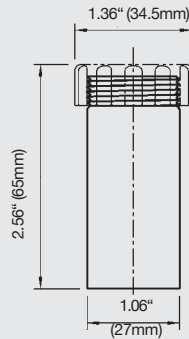

Pressure connections IS-20-S and IS-20-F

1/2 NPT male
Order code: ND

1/4 NPT male
Order code: NB

G 1/2 metric
EN 837
Order code: GD

G 1/4 metric
EN 837
Order code: GB

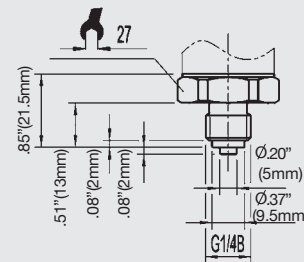
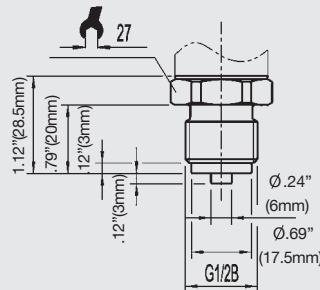
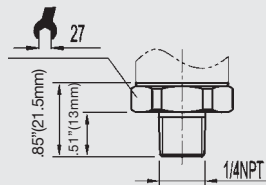
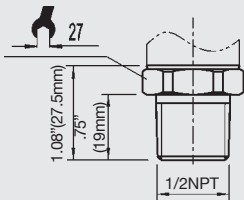

*) Mating connectors not included.

Electrical connections IS-2*-S

Cable with free ends, zero/span not adjustable, conductor outer diameter 6.8 mm, PUR IP 68/NEMA 6
Order code: EM
ATEX: 1/2 G, M1

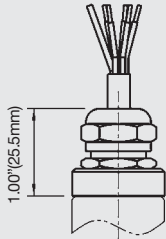

Other connections available

Electrical connections IS-2*-F

Integral junction box with internal spring clip terminals NEMA 4X IP 67
Order code:
FE (1/2" NPT female conduit standard)
FH (threaded connection brass nickel-plated)
FC (threaded connection stainless steel)
ATEX: 1/2 G, M1

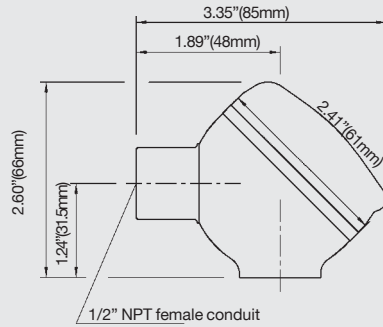

Electrical connections IS-2*-S

Cable with free ends, zero/span not adjustable, conductor outer diameter 7.5 mm, PUR {FEP} NEMA 6P / IP 68
Order code: DM
ATEX: 1G, 1D, M1

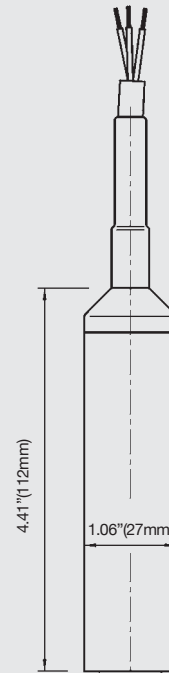

Case dimensions



IS-21-S and IS-21-F flush diaphragm pressure connections

G 1
50 INWC to 25 PSI
Order code: 85

G 1/2
30 PSI to 8,000 PSI
Order code: 86

G 1
according to EHEDG **)
100 INWC to 250 PSI
Order code: 83

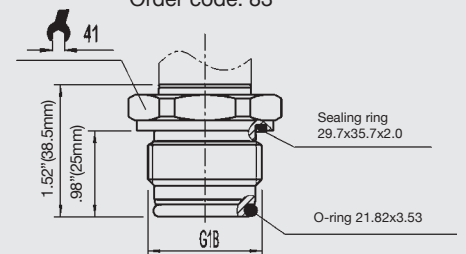
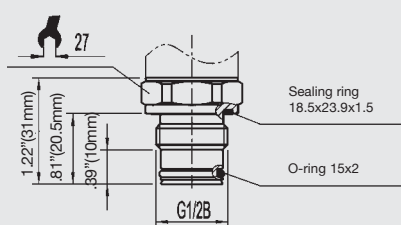
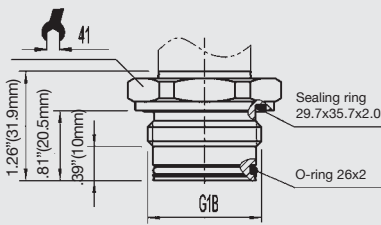

Matching P-1 weld insert adapters for IS-21-S and IS-21-F transmitters

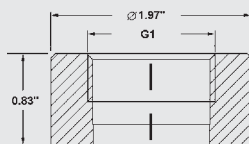

P-1 G1 weld insert adapter
Part # 1206974
for pressure ranges ≤ 25 PSI

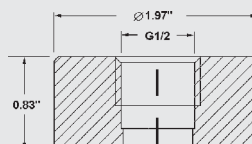

P-1 G1/2 weld insert adapter
Part # 1097008
for pressure ranges ≥ 30 PSI

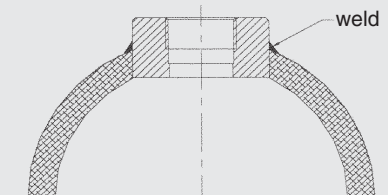

Cross section view of P-1 adapter installed in pipe.

**) European Hygienic Equipment Design Group
{ } Items in curved brackets are optional extras at additional cost.

pressure connections for high temperature media

IS-21-S and IS-21-F, flush diaphragm
-4 °F to 302 °F (-20 °C to 150 °C)

G 1/2
with 2 cooling fins (version **A**)
0 ... 30 PSI up to 0 ... 8000 PSI
Order code: 86 and C

IS-20-S and IS-20-F
-40 °F to 302 °F (-40 °C to 150 °C)

1/2 NPT male
with 3 cooling fins (version **B**)
0 - 5PSI to 0-15,000 PSI
Order code: ND and 8

IS-20-S and IS-20-F
-40 °F to 392 °F (-40 °C to 200 °C)

1/2 NPT male
with 5 cooling fins (version **C**)
0-5 PSI to 0-15,000 PSI
Order code: ND and 9

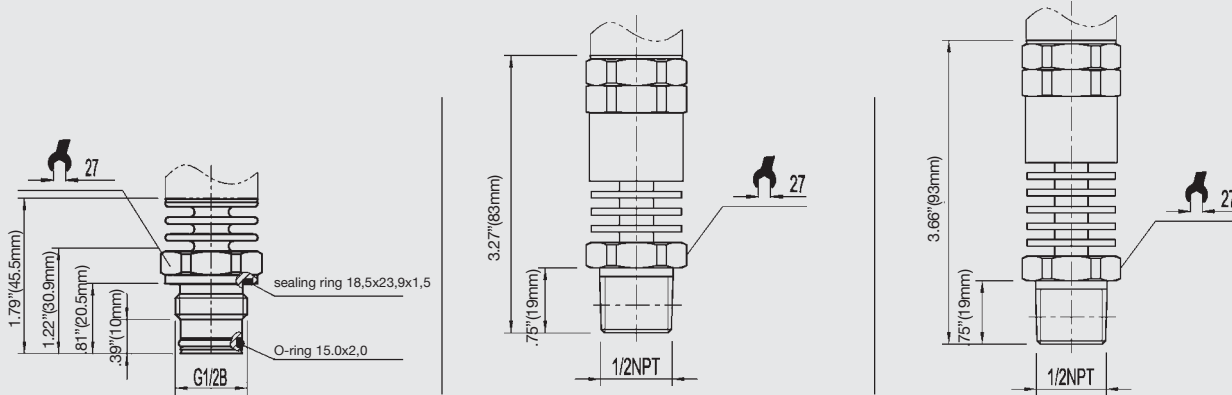

Relationship of media temperature to ambient temperature

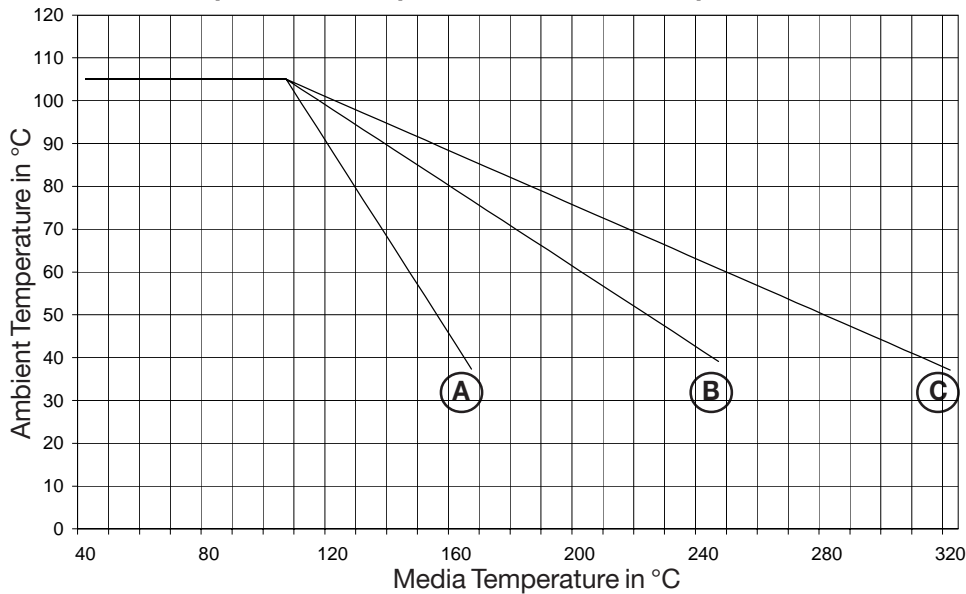

Version	A	B	C
Cooling fins	2	3	5
K *	0.47	0.68	0.76

*cooling constant specific to each version

Calculation of cooling element performance:

$$T_B = T_{med} - (T_{med} - T_{amb}) \times K$$

T_B = Operating temperature of transmitter

T_{med} = maximum temperature of process media

T_{amb} = maximum ambient temperature

K = Constant of cooling element

Maximum permissible ambient temperature:

$$T_{amb} = T_{med} + (T_B - T_{med}) / K$$

Wiring

Model IS-2*-S

2-wire

L-connector

Non hazardous area | Hazardous (classified) area

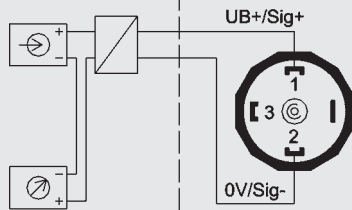

Circular connector

M 12x1

Non hazardous area | Hazardous (classified) area

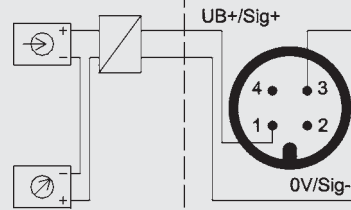

5 foot (1.5 m) of vented cable with free ends

Non hazardous area | Hazardous (classified) area

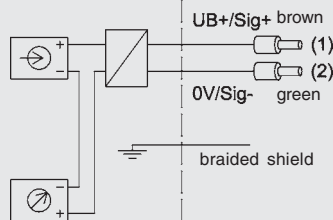

6 pin mil plug connector

Non hazardous area | Hazardous (classified) area

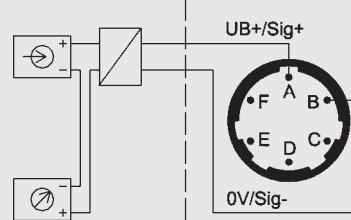

Model IS-2*-F

2-wire

Field case (internal spring clip terminal)

Non hazardous area | Hazardous (classified) area

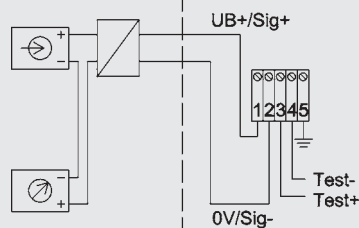

Legend

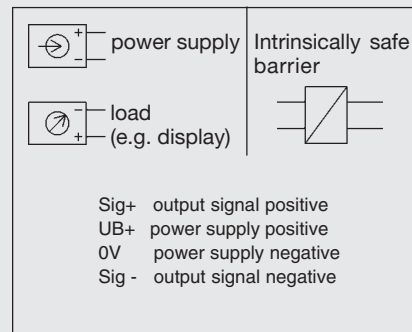

Hazardous areas (ATEX zone classifications)

Group II: Electrical equipment for use in all areas (except mines) which are endangered by an explosive atmosphere.

Zone	Category	Occurrence of explosive atmosphere
Zone 0	Category 1G (gas)	Continuous
Mounting to zone 0	Category 1/2 G	
Zone 20	Category 1D (dust)	
Mounting to zone 20	Category 1/2 D	
Zone 1	Category 2G	Intermittent
Zone 21	Category 2D	
Zone 2	Category 3G	Hazard under abnormal conditions
Zone 22	Category 3D	

Group I: Electrical equipment for use in mines (hazard due to mine gas)

Zone	Category	Requirements
	Category M1	Very high degree of safety
	Category M2	High degree of safety (instruments have to be turned off if they are exposed to an explosive atmosphere)

Hazardous areas (ATEX compared to FM and CSA)

		ATEX Group	FM / CSA Class	Group
Above ground	Gases and Vapours	IIA / IIB / IIC	I	A / B / C / D / E / F / G
	Dusts		II	
	Fibres		III	
Mining	Gas / Dusts	I	ID / IIF	

	Flammable material present continuously	Flammable material present intermittently	Flammable material normally not present
ATEX	Zone 0 (Zone 20 Dust)	Zone 1 (Zone 21 Dust)	Zone 2 (Zone 22 Dust)
FM / CSA	Zone 0	Zone 1	Zone 2
		Division 1	Division 2
FM (NEC505)	Zone 0	Zone 1	Zone 2

Specifications and dimensions provided in this data sheet represent the state of engineering at the time of printing. Modifications may take place and specified materials may change without prior notice.

